

# Surface Mount Gas Tube Surge Arrester

Part Number: 3SD4-145

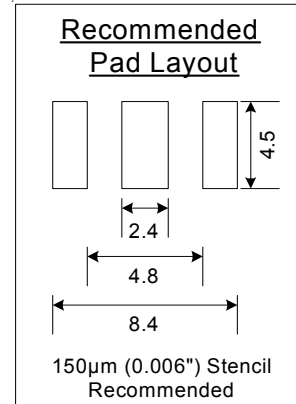
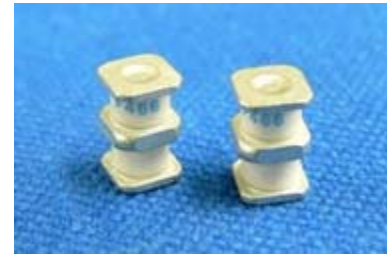
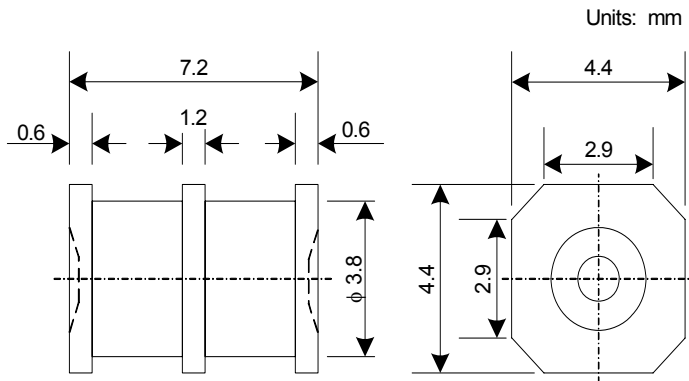

**Features:**

- UL 497B Recognized - File E140906
- RoHS Compliant - 100% Lead Free
- Very Low Capacitance: 0.5 pF
- Non-Radioactive
- ISO Certified

**Applications:**

- Transient Voltage Surge Suppression
- Telephone Network Interfaces
- Modems/Cable Modems
- xDSL Modems and Peripherals
- Building Entry/Outside Plant

**Packaging:**

Tape & Reel per EIA Standard. See page 2.

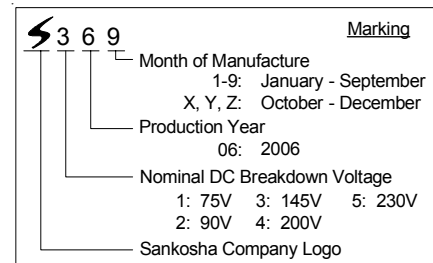

**Electrical Characteristics**

1.	DC Breakdown Voltage	100 V/sec	145V ± 20%	(L1-E) (L2-E)		
2.	Impulse Breakdown Voltage	100 V/µsec	< 500 V	(L1-E) (L2-E)		
		1 kV/µsec	< 600 V	(L1-E) (L2-E)		
3.	Insulation Resistance	DC 50 V	> 10,000 M-ohm			
4.	Capacitance	1 MHz	< 0.5 pF			
5.	DC Holdover Voltage	See Note	< 80V	Note: ITU-T K.12 or IEEE C62.31-1987 Test Circuit		
6.	Impulse Life	8/20 µsec	200 A	1,000 Times	(L1+L2-E)	
7.	Impulse Discharge Current	8/20 µsec	5 kA	(L1+L2-E)		
8.	AC Discharge Current	50 Hz	10 A	One Second	(L1+L2-E)	

**After Life Tests**

9.	DC Breakdown Voltage	100 V/sec	145V ± 30%			
10.	Impulse Breakdown Voltage	100 V/µsec	< 700 V			
11.	Insulation Resistance	DC 50 V	> 100 M-ohm			

SANKOSHA

SANKOSHA

# 3SD4 Series – Reel Dimensions

1,800 pcs. per reel

Sankosha U.S.A., Inc.  
www.sankosha-usa.com  
(888) 711-2436

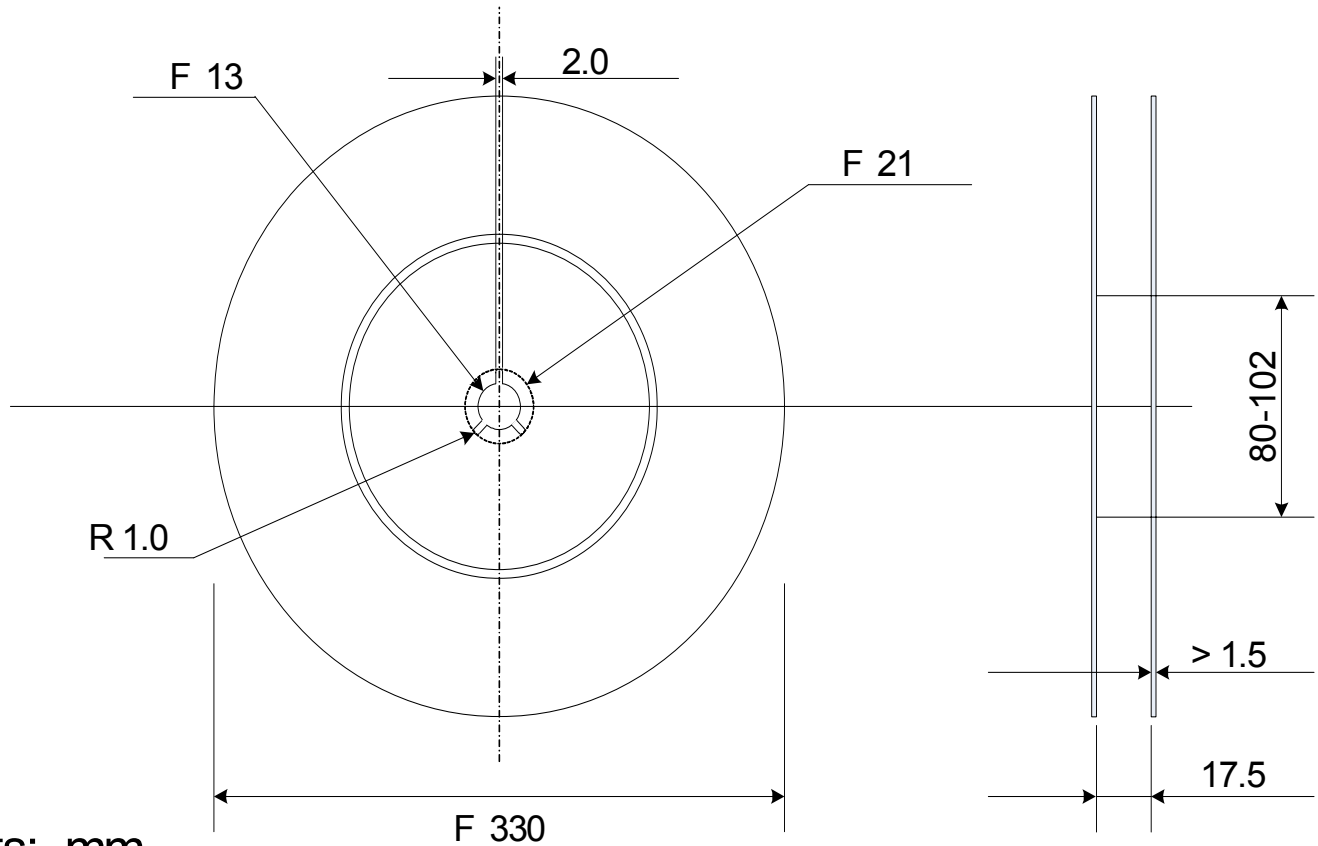

Units: mm

# 3SD4 Series Tape Dimensions

Unit: mm

